

proiectant ARHITECTURA	stampila ARHITECT	proiectant PSI	stampila VERIFICATOR

<b>INVENTAR TABLOU TAMPLARIE CLADIRE ASOCIATIA INFOCONS - ETAJ I</b>			
SUPRAFATA CONSTRUITA   187,45mp			
PROIECT	PROIECTANT GENERAL	 <b>InfoCons</b> <small>protectia-consumatorilor.ro</small>	PROIECT
CLADIRE BIROURI "ASOCIATIA INFOCONS"	HUZUR STUDIO		NR.H-A-0216
DEF. PROIECT	arh. urb. Radu SIMION	BENEFICIAR	FAZA
PROIECTAT	urb. Dan-Nicu CRISTESCU	ASOCIATIA INFOCONS	PROPLINERE ARH. (D.T.A.C.)
PREZENTAT	urb. Dan-Nicu CRISTESCU	IDENTIFICARE IMOBIL	DATA
VERIFICAT	arh. urb. Radu SIMION	str.VICTORULUI nr.133, BUCURESTI 5.2	01.09.2016
		TITLUL PLANSEI	SCARA
		PLAN TABLOU TAMPLARII ETAJ I (P.Th.)	1:50
			NR.PLANSA
			TTET-I-00

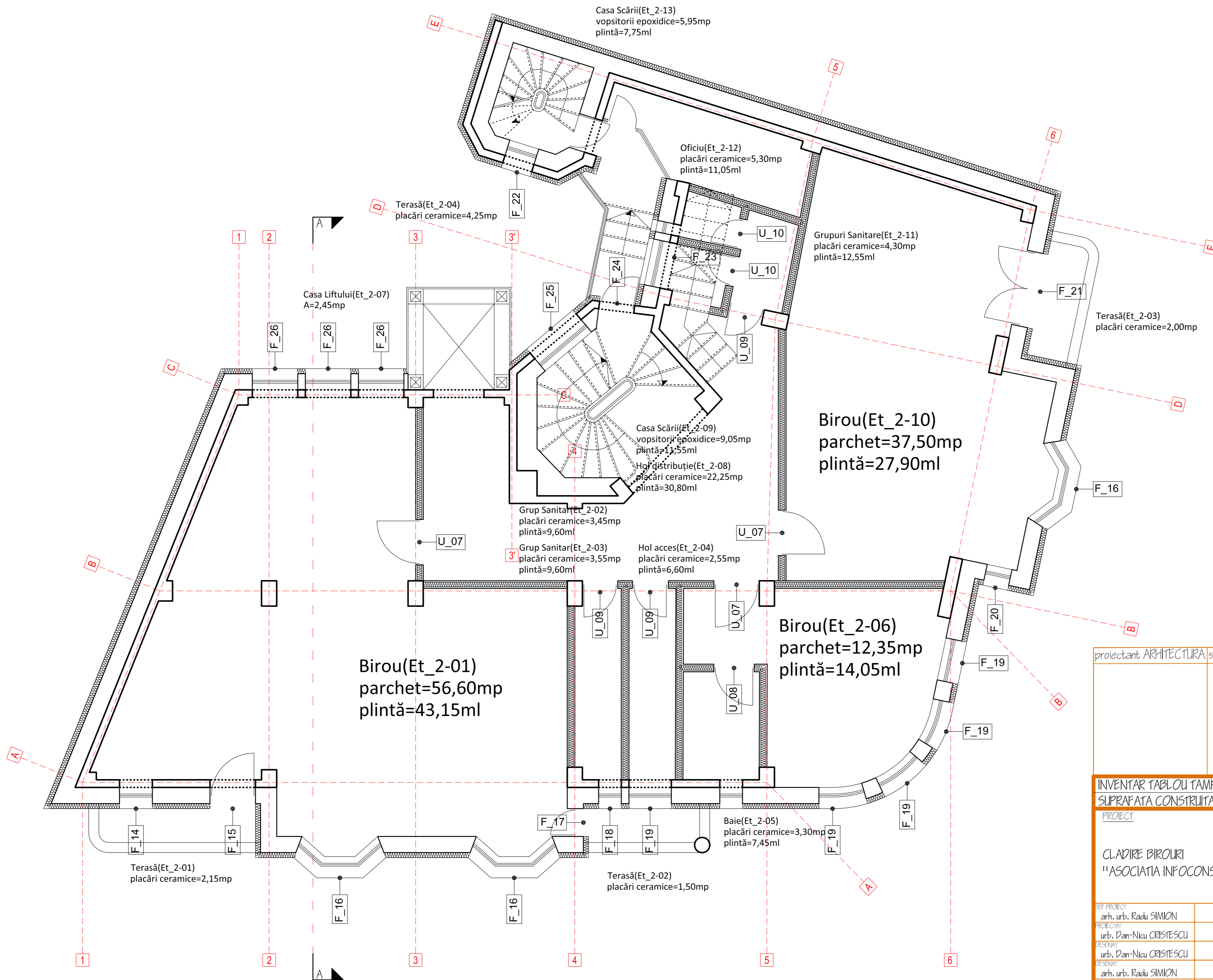

proiectant ARHITECTURA	stampila ARHITECT	proiectant PSI	stampila VERIFICATOR

INVENTAR TABLOU TAMPLARIE CLADIRE ASOCIATIA INFOCONS - ETAJ 2			
SUPRAFATA CONSTRUITA   187,45mp			
PROIECT	PROIECTANT GENERAL	PROIECT	
CLADIRE BIROURI "ASOCIATIA INFOCONS"	HUZUR STUDIO	NR./H-A-0216	
	BENEFICIAR	FAZA	
ASOCIATIA INFOCONS		PROPOUNERE ARH. (D.T.A.C.)	
		DATA	
		01.09.2016	
DEF. PROIECT		SCARA	
arh. urb. Radu SIMION		1:50	
PROIECTAT		NR. PLANSA	
urb. Dan-Nicu CRISTESCU	IDENTIFICARE IMOBIL		
PREZENTAT	str. VIITORULUI nr.133, BUCURESTI 5.2		
urb. Dan-Nicu CRISTESCU	TITLUL PLANSEI		
arh. urb. Radu SIMION	PLAN TABLOU TAMPLARIE ETAJ 2 (P.Th.)		
VERIFICAT			
arh. urb. Radu SIMION		TTEt.2-00	

**F\_14****ASOCIATIA INFOCONS**
**TABLOU TÂMLĂRIE  
FERESTRE**
**InfoCons**  
 protectia-consumatorilor.ro

 str.VIITORULUI 133  
 S.2 BUCURESTI
**DESCRIERE:****CARACTERISTICI TEHNICE :**
 FEREASTRA CU TAMPLARIE DIN P.V.C., CU GEAM  
 DUBLU TERMOIZOLANT, LOW-E, 2 CANATURI

CULOARE PIN

**CARACTERISTICI FUNCȚIONALE :**

DESCHIDERE OSCILO-BATANTA

AMPLASARE CORP LOCATIE	NUMAR BUCATI	ALCATUIRE PERETE	REFERINȚE NORMATE
F_14	2	ZIDARIE CARAMIDA 32cm TERMOISISTEM - 10cm	FARA AERISIRE

ELEVATIE TAMPLARIE	SCARA 1:40	ELEVATIE GOL	SCARA 1:40
--------------------	------------	--------------	------------

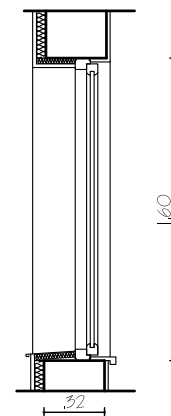
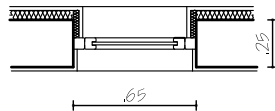
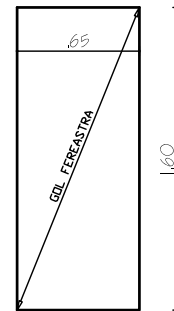
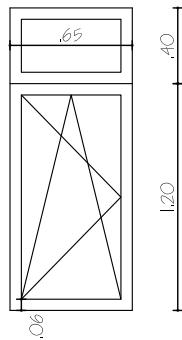

PLAN	SCARA 1:40	SECTIUNE	SCARA 1:40
------	------------	----------	------------

REVIZII	DATA	REV. NR. :	000
001			
002			
003			
004			

OBSERVATII :	CURTE FRANCEZA
--------------	----------------

SEF PROIECT	arh. urb. Radu SIMION	FAZA :	D.D.E.	PROIECT NR : H_A_0216
PROIECTAT	arh. urb. Radu SIMION	DATA :	10.08.2016	REVIZIA : 000
DESENAT	arh. Dan-Nicu CRISTESCU			
DESENAT	arh. urb. Radu SIMION			
VERIFICAT	arh. Sandu STIURCA			

**F\_15****ASOCIATIA INFOCONS****TABLOU TÂMPLĂRIE  
FERESTRE****InfoCons**  
protectia-consumatorilor.rostr. VIITORULUI 133  
S.2 BUCURESTI**DESCRIERE:****CARACTERISTICI TEHNICE :**USA CU TAMPLARIE DIN P.V.C., CU GEAM DUBLU  
TERMOIZOLANT, LOW-E, 2 CANATURI

CULOARE PIN

**MATERIALE ȘI ACCESORII :**

AMPLASARE CORP LOCATIE

NUMAR BUCATI

ALCATUIRE PERETE

FINISAJ

F\_15

2-DESCHIDERE STANGA

ZIDARIE/B.A.

VOPSEA LAVABILA

**ELEVATIE TAMPLARIE**

SCARA 1:40

**ELEVATIE GOL**

SCARA 1:40

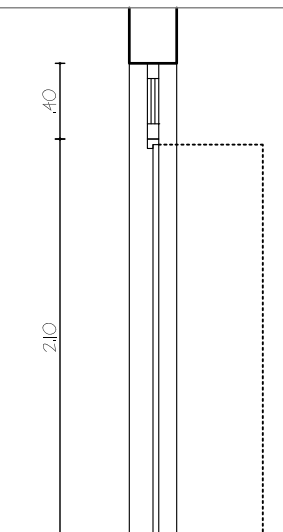
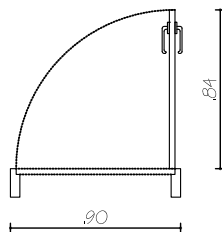
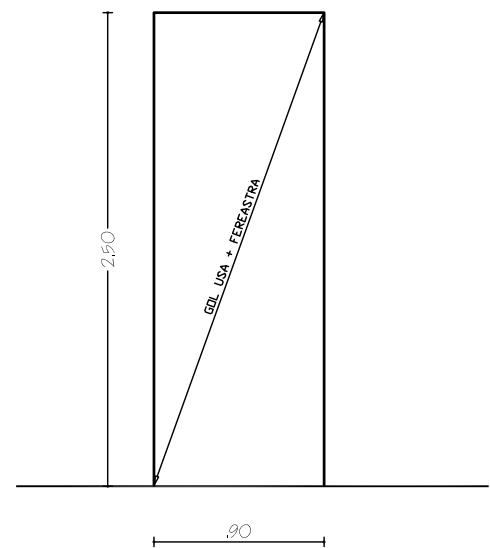
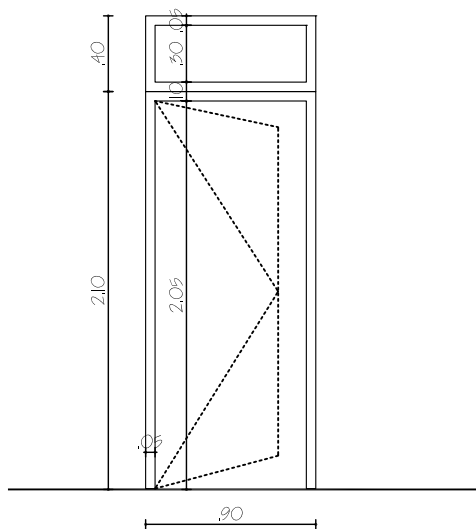
**PLAN**

SCARA 1:40

**SECTIUNE**

SCARA 1:40

REVIZII DATA

REV. NR. : 000

OBSERVATII :

001

USA DE EXTERIOR

002

003

004

SEF PROIECT

arh. urb. Radu SIMION

FAZA :

D.D.E.

PROIECT NR : H\_A\_0216

PROIECTAT

arh. urb. Radu SIMION

DATA :

10.08.2016

REVIZIA : 000

DESENAT

arh. Dan-Nicu CRISTESCU

DESENAT

arh. urb. Radu SIMION

VERIFICAT

arh. Sandu STIURCA

**F\_16****ASOCIATIA INFOCONS**
**TABLOU TÂMPLĂRIE  
FERESTRE**
**InfoCons**  
 protecția-consumatorilor.ro

 str. VIITORULUI 133  
 S.2 BUCUREȘTI
**DESCRIERE:****CARACTERISTICI TEHNICE :**
 FEREASTRA CU TAMPLARIE DIN P.V.C., CU GEAM  
 DUBLU TERMOIZOLANT, LOW-E, 3 CANATURI

CULOARE PIN

**CARACTERISTICI FUNCȚIONALE :**

DEȘCHIDERE OSCILĂ-BATĂNȚĂ

AMPLASARE CORP LOCATIE	NUMAR BUCATI	ALCATUIRE PERETE	REFERINȚE NORMATE
F_16	6	ZIDARIE CARAMIDA 32cm TERMOȘISTEM - 10cm	FARA AERISIRE
ELEVATIE TAMPLARIE SCARA 1:40		ELEVATIE GOL SCARA 1:40	

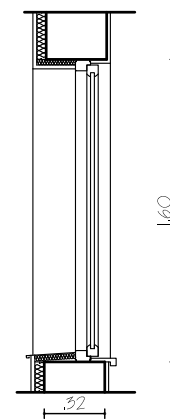
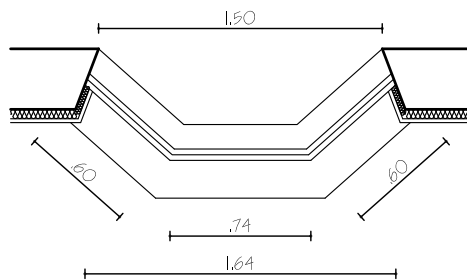
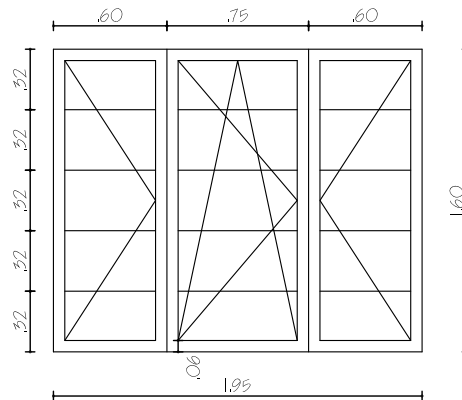

PLAN		SCARA 1:40	SECTIUNE	SCARA 1:40
REVIZII	DATA	REV. NR. : 000	OBSERVAȚII : CURTE FRANCEZA	
001				
002				
003				
004				
SEF PROIECT	arh. urb. Radu SIMION		FAZA :	PROIECT NR : H_A_0216
PROIECTAT	arh. urb. Radu SIMION		D.D.E.	REVIZIA : 000
DESENAT	arh. Dan-Nicu CRISTESCU		DATA :	
DESENAT	arh. urb. Radu SIMION		10.08.2016	
VERIFICAT	arh. Sandu STIURCA			

F\_17



ASOCIATIA INFOCONS

TABLOU TÂMPĂRIE  
FERESTRE
**InfoCons**  
 protectia-consumatorilor.ro

 str.VIIITORULUI 133  
 S.2 BUCURESTI

## DESCRIERE:

## CARACTERISTICI TEHNICE :

 USA CU TAMPLARIE DIN P.V.C., CU GEAM DUBLU  
 TERMOIZOLANT, LOW-E, 2 CANATURI

CULOARE PIN

## MATERIALE ȘI ACCESORII :

AMPLASARE CORP LOCATIE

NUMAR BUCATI

ALCATUIRE PERETE

FINISAJ

F\_17

2-DESCHIDERE DREAPTA

ZIDARIE/B.A.

VOPSEA LAVABILA

## ELEVATIE TAMPLARIE

SCARA 1:40

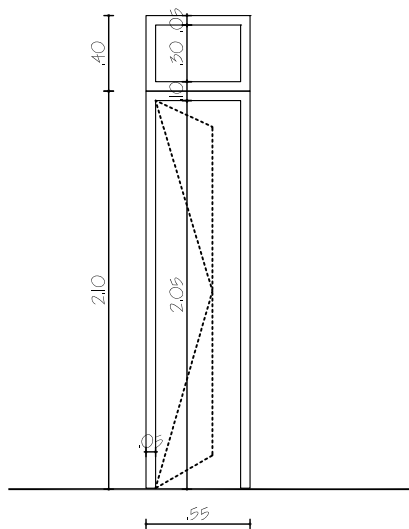

## ELEVATIE GOL

SCARA 1:40

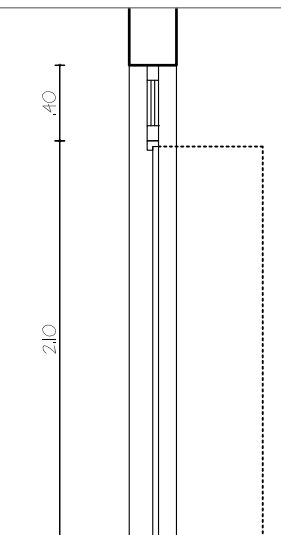
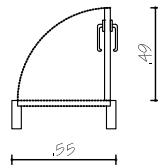
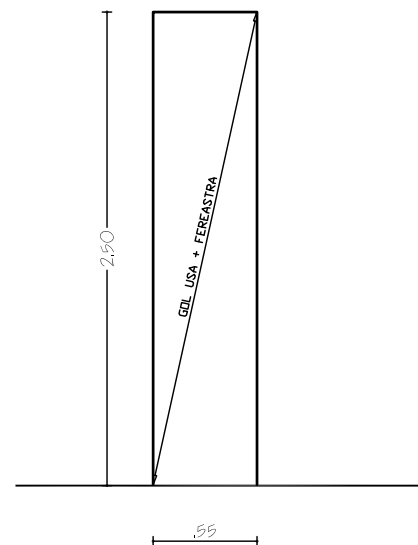

PLAN

SCARA 1:40

SECTIUNE

SCARA 1:40

REVIZII DATA

REV. NR. : 000

OBSERVATII :

001

USA DE EXTERIOR

002

003

004

SEF PROIECT

arh. urb. Radu SIMION

FAZA :

D.D.E.

PROIECT NR : H\_A\_0216

PROIECTAT

arh. urb. Radu SIMION

DATA :

10.08.2016

REVIZIA : 000

DESENAT

arh. Dan-Nicu CRISTESCU

DESENAT

arh. urb. Radu SIMION

VERIFICAT

arh. Sandu STIURCA

**F\_18****ASOCIATIA INFOCONS**
**TABLOU TÂMPĂRIE  
FERESTRE**
**InfoCons**  
 protectia-consumatorilor.ro

 str. VIITORULUI 133  
 S.2 BUCURESTI
**DESCRIERE:****CARACTERISTICI TEHNICE :**
 FEREASTRA CU TAMPLARIE DIN P.V.C., CU GEAM  
 DUBLU TERMOIZOLANT, LOW-E, 2 CANATURI

CULOARE PIN

**CARACTERISTICI FUNCȚIONALE :**

DESCHIDERE OSCILĂ-BATĂNĂ

AMPLASARE CORP LOCATIE

NUMAR BUCATI

ALCATUIRE PERETE

REFERINȚE NORMATE

F\_18

2

ZIDARIE CARAMIDA 32cm  
TERMOȘISTEM - 10cm

FARA AERISIRE

ELEVATIE TAMPLARIE

SCARA 1:40

ELEVATIE GOL

SCARA 1:40

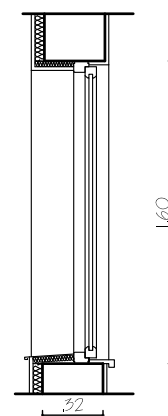
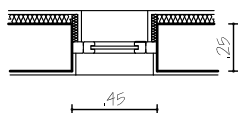
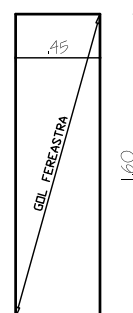
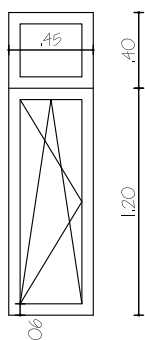

PLAN

SCARA 1:40

SECȚIUNE

SCARA 1:40

REVIZII DATA

REV. NR. : 000

OBSERVAȚII :  
CURTE FRANCEZA

001

002

003

004

SEF PROIECT

arh. urb. Radu SIMION

PROIECTAT

arh. urb. Radu SIMION

DESENAT

arh. Dan-Nicu CRISTESCU

DESENAT

arh. urb. Radu SIMION

VERIFICAT

arh. Sandu STIURCA

FAZA :

D.D.E.

PROIECT NR : H\_A\_0216

DATA :

10.08.2016

REVIZIA : 000

**F\_19**

ASOCIATIA INFOCONS

**TABLOU TÂMPĂRIE  
FERESTRE**
**InfoCons**  
 protectia-consumatorilor.ro

 str. VIITORULUI 133  
 S.2 BUCURESTI
**DESCRIERE:****CARACTERISTICI TEHNICE :**
 FEREASTRA CU TAMPLARIE DIN P.V.C., CU GEAM  
 DUBLU TERMOIZOLANT, LOW-E, 2 CANATURI

CULOARE PIN

**CARACTERISTICI FUNCȚIONALE :**

DESCHIDERE OSCILO-BATANTA

AMPLASARE CORP LOCATIE	NUMAR BUCATI	ALCATUIRE PERETE	REFERINȚE NORMATE
F_19	10	ZIDARIE CARAMIDA 32cm TERMO SISTEM - 10cm	FARA AERISIRE
<b>ELEVATIE TAMPLARIE</b> SCARA 1:40		<b>ELEVATIE GOL</b> SCARA 1:40	

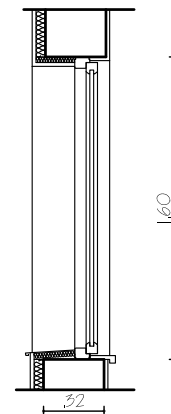
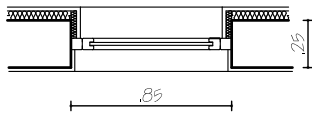
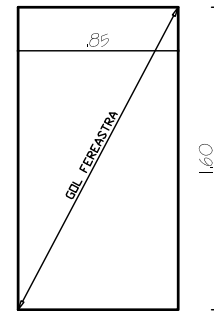
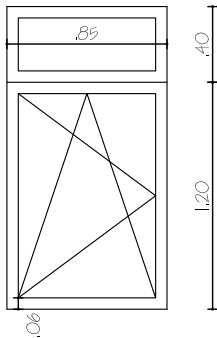

PLAN		SCARA 1:40	SECTIUNE	SCARA 1:40
REVIZII	DATA	REV. NR. : 000	OBSERVATII : CURTE FRANCEZA	
001				
002				
003				
004				
SEF PROIECT	arh. urb. Radu SIMION		FAZA :	PROIECT NR : H_A_0216
PROIECTAT	arh. urb. Radu SIMION		D.D.E.	REVIZIA : 000
DESENAT	arh. Dan-Nicu CRISTESCU		DATA :	
DESENAT	arh. urb. Radu SIMION		10.08.2016	
VERIFICAT	arh. Sandu STIURCA			



**F\_20****ASOCIATIA INFOCONS**
**TABLOU TÂMPĂRIE  
FERESTRE**
**InfoCons**  
 protectia-consumatorilor.ro

 str. VIITORULUI 133  
 S.2 BUCURESTI
**DESCRIERE:****CARACTERISTICI TEHNICE :**
 FEREASTRA CU TAMPLARIE DIN P.V.C., CU GEAM  
 DUBLU TERMOIZOLANT, LOW-E, 2 CANATURI

CULOARE PIN

**CARACTERISTICI FUNCȚIONALE :**

DESCHIDERE OSCILO-BATANTA

AMPLASARE CORP LOCATIE	NUMAR BUCATI	ALCATUIRE PERETE	REFERINȚE NORMATE
F_20	2	ZIDARIE CARAMIDA 32cm TERMOISISTEM - 10cm	FARA AERISIRE
<b>ELEVATIE TAMPLARIE</b> SCARA 1:40		<b>ELEVATIE GOL</b> SCARA 1:40	

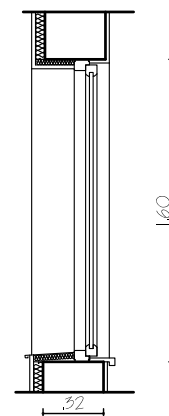
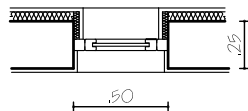
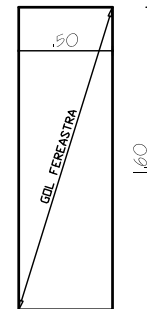
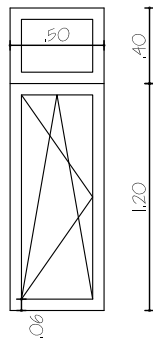

PLAN		SCARA 1:40	SECTIUNE	SCARA 1:40
REVIZII	DATA	REV. NR. : 000	OBSERVATII : CURTE FRANCEZA	
001				
002				
003				
004				
SEF PROIECT	arh. urb. Radu SIMION		FAZA :	PROIECT NR : H_A_0216
PROIECTAT	arh. urb. Radu SIMION		D.D.E.	REVIZIA : 000
DESENAT	arh. Dan-Nicu CRISTESCU		DATA :	
DESENAT	arh. urb. Radu SIMION		10.08.2016	
VERIFICAT	arh. Sandu STIURCA			

**F\_21****ASOCIATIA INFOCONS****TABLOU TÂMLĂRIE  
FERESTRE****InfoCons**  
protectia-consumatorilor.rostr. VIITORULUI 133  
S.2 BUCURESTI**DESCRIERE:****CARACTERISTICI TEHNICE :**USA CU TAMPLARIE DIN P.V.C., CU GEAM DUBLU  
TERMOIZOLANT, LOW-E, 4 CANATURI

CULOARE PIN

**MATERIALE ȘI ACCESORII :**

AMPLASARE CORP LOCATIE

NUMAR BUCATI

ALCATUIRE PERETE

FINISAJ

F\_21

2-DESIDERE ST/DR

ZIDARIE/B.A.

VOPSEA LAVABILA

**ELEVATIE TAMPLARIE**

SCARA 1:40

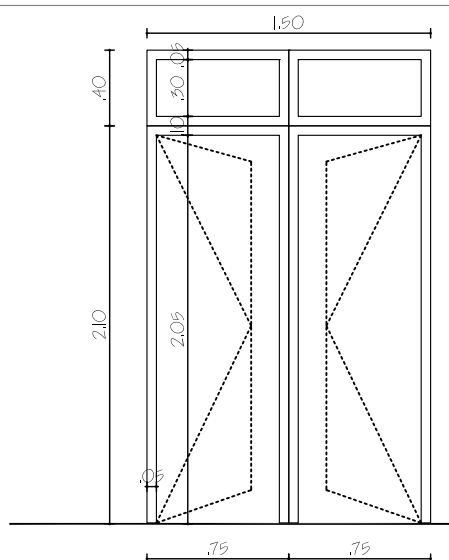
**ELEVATIE GOL**

SCARA 1:40

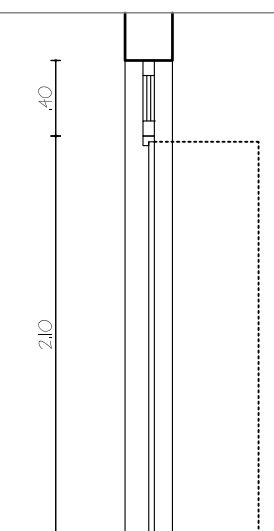
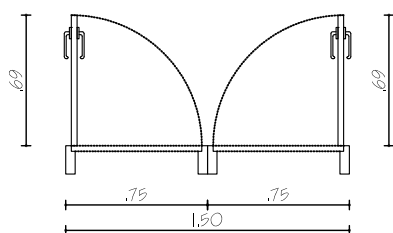
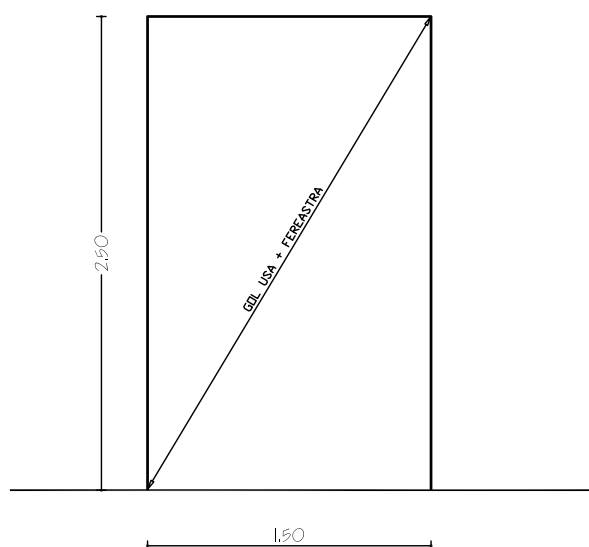
**PLAN**

SCARA 1:40

**SECTIUNE**

SCARA 1:40

REVIZII	DATA
001	
002	
003	
004	

REV. NR. : 000

OBSERVATII :

USA DE EXTERIOR

SEF PROIECT	arh. urb. Radu SIMION
PROIECTAT	arh. urb. Radu SIMION
DESENAT	arh. Dan-Nicu CRISTESCU
DESENAT	arh. urb. Radu SIMION
VERIFICAT	arh. Sandu STIURCA

FAZA : D.D.E.

PROIECT NR : H\_A\_0216

DATA : 10.08.2016

REVIZIA : 000

F\_22



ASOCIATIA INFOCONS

TABLOU TÂMLĂRIE  
FERESTRE
**InfoCons**  
 protectia-consumatorilor.ro

 str. VIITORULUI 133  
 S.2 BUCURESTI

## DESCRIERE:

## CARACTERISTICI TEHNICE :

 FEREASTRA CU TAMPLARIE DIN P.V.C., CU GEAM  
 DUBLU TERMOIZOLANT, LOW-E, 1 CANAT

CULOARE PIN

## CARACTERISTICI FUNCȚIONALE :

DESCHIDERE OSCILO-BATANTA

AMPLASARE CORP LOCATIE

NUMAR BUCATI

ALCATUIRE PERETE

REFERINȚE NORMATE

F\_22

2

 ZIDARIE CARAMIDA 32cm  
 TERMOISITEM - 10cm

FARA AERISIRE

ELEVATIE TAMPLARIE

SCARA 1:40

ELEVATIE GOL

SCARA 1:40

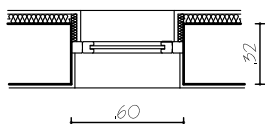
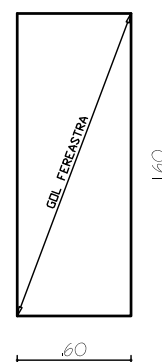
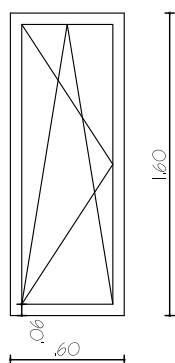

PLAN

SCARA 1:40

SECȚIUNE

SCARA 1:40

REVIZII DATA

REV. NR. : 000

OBSERVAȚII :  
CURTE FRANCEZA

001

002

003

004

SEF PROIECT

arh. urb. Radu SIMION

PROIECTAT

arh. urb. Radu SIMION

DESENAT

arh. Dan-Nicu CRISTESCU

DESENAT

arh. urb. Radu SIMION

VERIFICAT

arh. Sandu STIURCA

FAZA :

D.D.E.

PROIECT NR : H\_A\_0216

DATA :

10.08.2016

REVIZIA : 000

**F\_23****ASOCIATIA INFOCONS**
**TABLOU TÂMPLĂRIE  
FERESTRE**
**InfoCons**  
 protectia-consumatorilor.ro

 str. VIITORULUI 133  
 S.2 BUCURESTI
**DESCRIERE:****CARACTERISTICI TEHNICE :**
 FEREASTRA CU TAMPLARIE DIN P.V.C., CU GEAM  
 DUBLU TERMOIZOLANT, LOW-E, 2 CANATURI

CULOARE PIN

**CARACTERISTICI FUNCȚIONALE :**

DESCHIDERE OSCILO-BATANTA

AMPLASARE CORP LOCATIE

F\_23

NUMAR BUCATI

2

ALCATUIRE PERETE

ZIDARIE CARAMIDA 32cm  
TERMOISISTEM - 10cm

REFERINȚE NORMATE

FARA AERISIRE

ELEVATIE TAMPLARIE

SCARA 1:40

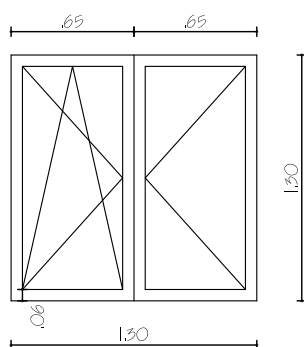

ELEVATIE GOL

SCARA 1:40

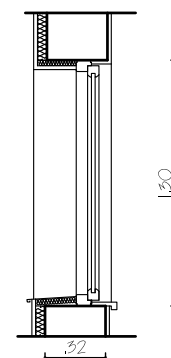
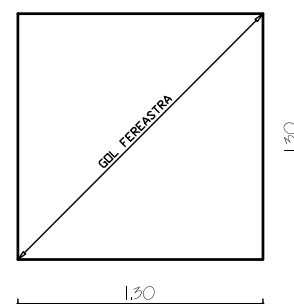

PLAN

SCARA 1:40

REVIZII	DATA
001	
002	
003	
004	

REV. NR. : 000

SECTIUNE

SCARA 1:40

OBSERVATII :  
CURTE FRANCEZA

SEF PROIECT	arh. urb. Radu SIMION
PROIECTAT	arh. urb. Radu SIMION
DESENAT	arh. Dan-Nicu CRISTESCU
DESENAT	arh. urb. Radu SIMION
VERIFICAT	arh. Sandu STIURCA

FAZA : D.D.E.

PROIECT NR : H\_A\_0216

DATA : 10.08.2016

REVIZIA : 000

**F\_24**



**ASOCIATIA INFOCONS**

**TABLOU TÂMPLĂRIE  
FERESTRE**

**InfoCons**  
protectia-consumatorilor.ro

str.VIITORULUI 133  
S.2 BUCURESTI

**DESCRIERE:**

**CARACTERISTICI TEHNICE :**

FOAIE DE USA DIN STICLA, CU DOUA SAU TREI  
BALAMALE  
USA EXTERIOR

**MATERIALE ȘI ACCESORII :**

STICLA SECURIZATA  
FARA TOC SAU TOC METALIC  
BALAMALE ALAMA  
MANER, SILD, ROZETA ALAMA

AMPLASARE CORP LOCATIE	NUMAR BUCATI	ALCATUIRE PERETE	FINISAJ
F_24	2-DESCHIDERE DREAPTA	ZIDARIE/B.A.	VOPSEA LAVABILA

**ELEVATIE TAMPLARIE SCARA 1:40**      **ELEVATIE GOL SCARA 1:40**

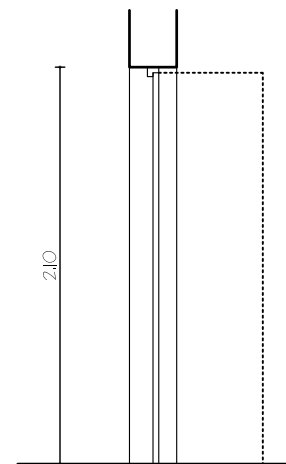
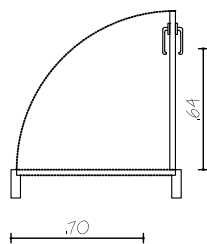
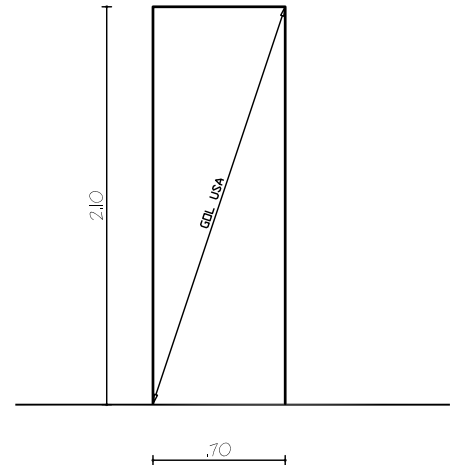
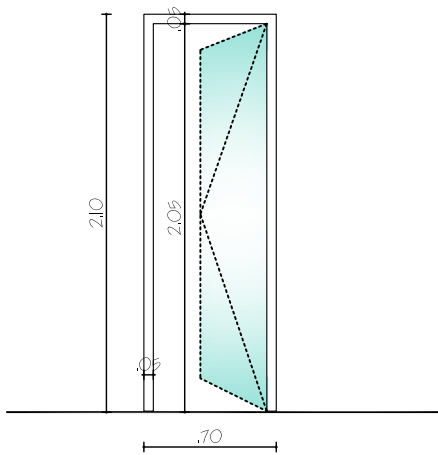

**PLAN SCARA 1:40**      **SECTIUNE SCARA 1:40**

REVIZII	DATA	REV. NR. : 000
001		
002		
003		
004		

OBSERVATII :  
USA DE INTERIOR

SEF PROIECT	arh. urb. Radu SIMION	FAZA :	D.D.E.	PROIECT NR : H_A_0216
PROIECTAT	arh. urb. Radu SIMION	DATA :	10.08.2016	REVIZIA : 000
DESENAT	arh. Dan-Nicu CRISTESCU			
DESENAT	arh. urb. Radu SIMION			
VERIFICAT	arh. Sandu STIURCA			

**F\_25****ASOCIATIA INFOCONS****TABLOU TÂMPLĂRIE  
FERESTRE****InfoCons**  
protectia-consumatorilor.rostr. VIITORULUI 133  
S.2 BUCURESTI**DESCRIERE:****CARACTERISTICI TEHNICE :**FEREAȘTRA CU TAMPLĂRIE DIN P.V.C., CU GEAM  
DUBLU TERMOIZOLANT, LOW-E, 1 CANAT

CULOARE PIN

**CARACTERISTICI FUNCȚIONALE :**

DEȘCHIDERE OSCILO-BATANTA

AMPLASARE CORP LOCATIE

NUMAR BUCATI

ALCATUIRE PERETE

REFERINȚE NORMATE

F\_25

2

ZIDARIE CARAMIDA 32cm  
TERMOȘISTEM - 10cm

FARA AERISIRE

ELEVATIE TAMPLĂRIE

SCARA 1:40

ELEVATIE GOL

SCARA 1:40

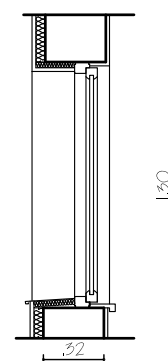
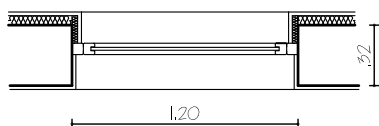
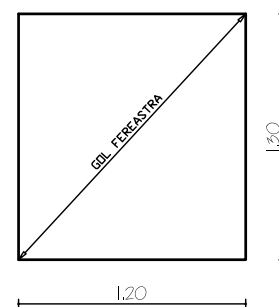
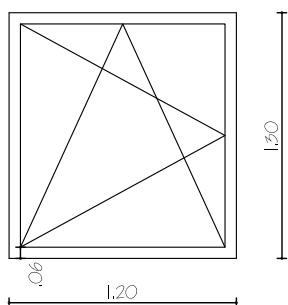

PLAN

SCARA 1:40

SECTIUNE

SCARA 1:40

REVIZII DATA

REV. NR. : 000

OBSERVATII :  
CURTE FRANCEZA

001

002

003

004

SEF PROIECT  
PROIECTATarh. urb. Radu SIMION  
arh. urb. Radu SIMION

DEȘENAT

arh. Dan-Nicu CRISTESCU

DEȘENAT

arh. urb. Radu SIMION

VERIFICAT

arh. Sandu ȘTIURCA

FAZA :

D.D.E.

PROIECT NR : H\_A\_0216

DATA :

10.08.2016

REVIZIA : 000

**F\_26****ASOCIATIA INFOCONS****TABLOU TÂMPLĂRIE  
FERESTRE****InfoCons**  
protectia-consumatorilor.rostr. VIITORULUI 133  
S.2 BUCURESTI**DESCRIERE:****CARACTERISTICI TEHNICE :**FEREASTRA CU TAMPLARIE DIN P.V.C., CU GEAM  
DUBLU TERMOIZOLANT, LOW-E, 1 CANAT

CULOARE PIN

**CARACTERISTICI FUNCȚIONALE :**

DESCHIDERE OSCILO-BATANTA

AMPLASARE CORP LOCATIE	NUMAR BUCATI	ALCATUIRE PERETE	REFERINȚE NORMATE
F_26	6	ZIDARIE CARAMIDA 32cm TERMOISISTEM - 10cm	FARA AERISIRE
ELEVATIE TAMPLARIE		ELEVATIE GOL	
SCARA 1:40		SCARA 1:40	

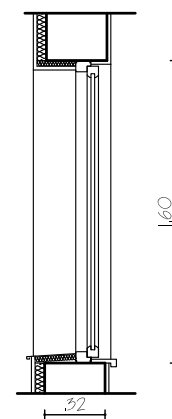
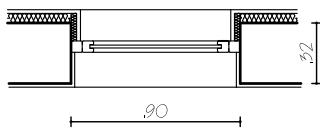
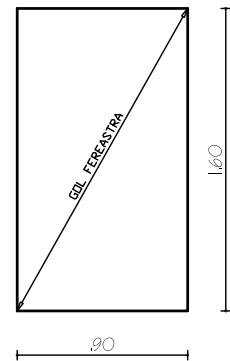
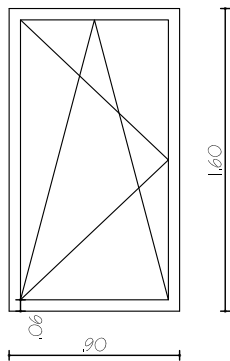

PLAN		SCARA 1:40		SECȚIUNE		SCARA 1:40	
REVIZII	DATA	REV. NR. : 000		OBSERVAȚII : CURTE FRANCEZA			
001							
002							
003							
004							
SEF PROIECT	arh. urb. Radu SIMION			FAZA :	D.D.E.	PROIECT NR : H_A_0216	
PROIECTAT	arh. urb. Radu SIMION			DATA :	10.08.2016	REVIZIA : 000	
DESENAT	arh. Dan-Nicu CRISTESCU						
DESENAT	arh. urb. Radu SIMION						
VERIFICAT	arh. Sandu STIURCA						