

proiectant ARHITECTURA	stampila ARHITECT	proiectant PSI	stampila VERIFICATOR

INVENTAR TABLOU TAMPLARIE CLADIRE ASOCIATIA INFOCONS - PARTER			
SUPRAFATA CONSTRUITA 156,20mp			
PROIECT	PROIECTANT GENERAL	 InfoCons <small>protectia-consumatorilor.ro</small>	PROIECT
CLADIRE BIROURI "ASOCIATIA INFOCONS"	HUZUR STUDIO		NR. H-A-0216
DEF. PROIECT	arh. urb. Radu SIMION	BENEFICIAR	FAZA
PROIECTAT	urb. Dan-Nicu CRISTESCU	ASOCIATIA INFOCONS	PROPLINERE ARH. (D.T.A.C.)
PREZENTAT	urb. Dan-Nicu CRISTESCU	IDENTIFICARE IMOBIL	DATA
VERIFICAT	arh. urb. Radu SIMION	str. VIITORULUI nr.133, BUCURESTI 5.2	01.09.2016
		TITLUL PLANSEI	SCARA
		PLAN TABLOU TAMPLARIE PARTER (P.Th.)	1:50
			NR. PLANSA
			TP-00

F_04**ASOCIATIA INFOCONS**
**TABLOU TÂMLĂRIE
FERESTRE**
InfoCons
 protectia-consumatorilor.ro

 str. VIITORULUI 133
 S.2 BUCURESTI
DESCRIERE:**CARACTERISTICI TEHNICE :**
 FEREAȘTRA CU TAMPLĂRIE DIN P.V.C., CU GEAM
 DUBLU TERMOIZOLANT, LOW-E, 2 CANATURI

CULOARE PIN

CARACTERISTICI FUNCȚIONALE :

DEȘCHIDERE OSCILĂ-BATĂNTĂ

AMPLASARE CORP LOCATIE	NUMAR BUCATI	ALCATUIRE PERETE	REFERINȚE NORMATE
F_04	2	ZIDĂRIE CĂRAMIDA 32cm TERMOȘISTEM - 10cm	FĂRĂ AERISIRE

ELEVATIE TAMPLĂRIE	SCARA 1:40	ELEVATIE GOL	SCARA 1:40
--------------------	------------	--------------	------------

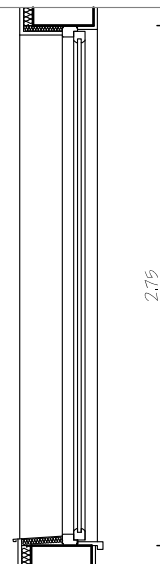
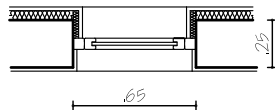
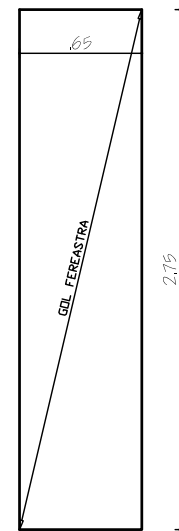
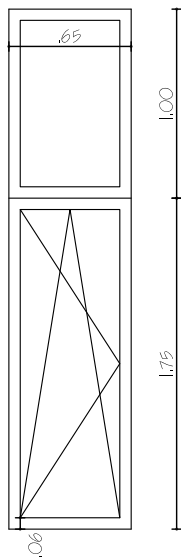

PLAN	SCARA 1:40	SECȚIUNE	SCARA 1:40
------	------------	----------	------------

REVIZII	DATA	REV. NR. :	000
001			
002			
003			
004			

 OBSERVAȚII :
 CURTE FRANCEZA

SEF PROIECT	arh. urb. Radu SIMION	FAZA :	D.D.E.	PROIECT NR : H_A_0216
PROIECTAT	arh. urb. Radu SIMION	DATA :	10.08.2016	REVIZIA : 000
DEȘENAT	arh. Dan-Nicu CRISTESCU			
DEȘENAT	arh. urb. Radu SIMION			
VERIFICAT	arh. Sandu ȘTIURCA			

F_05
ASOCIATIA INFOCONS
**TABLOU TÂMPLĂRIE
FERESTRE**
InfoCons
 protectia-consumatorilor.ro

 str.VIITORULUI 133
 S.2 BUCURESTI

DESCRIERE:
CARACTERISTICI TEHNICE :

 USA CU TAMPLARIE DIN P.V.C., CU GEAM DUBLU
 TERMOIZOLANT, LOW-E, 2 CANATURI

CULOARE PIN

MATERIALE ȘI ACCESORII :

AMPLASARE CORP LOCATIE	NUMAR BUCATI	ALCATUIRE PERETE	FINISAJ
F_05	3-DESIDERE DREAPTA 2-DESIDERE STANGA	ZIDARIE/B.A.	VOPSEA LAVABILA

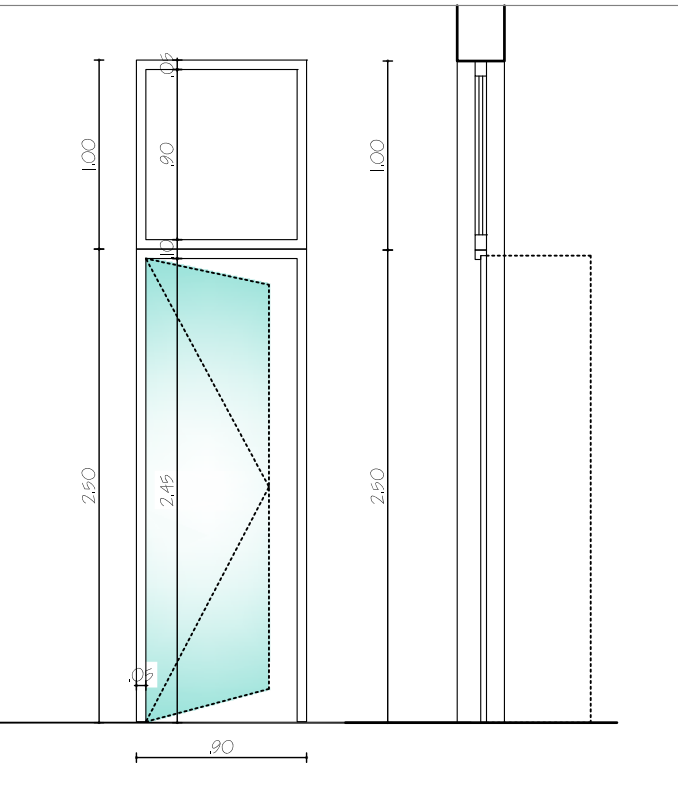
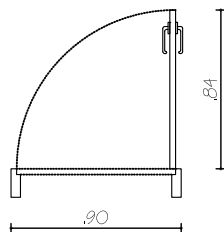
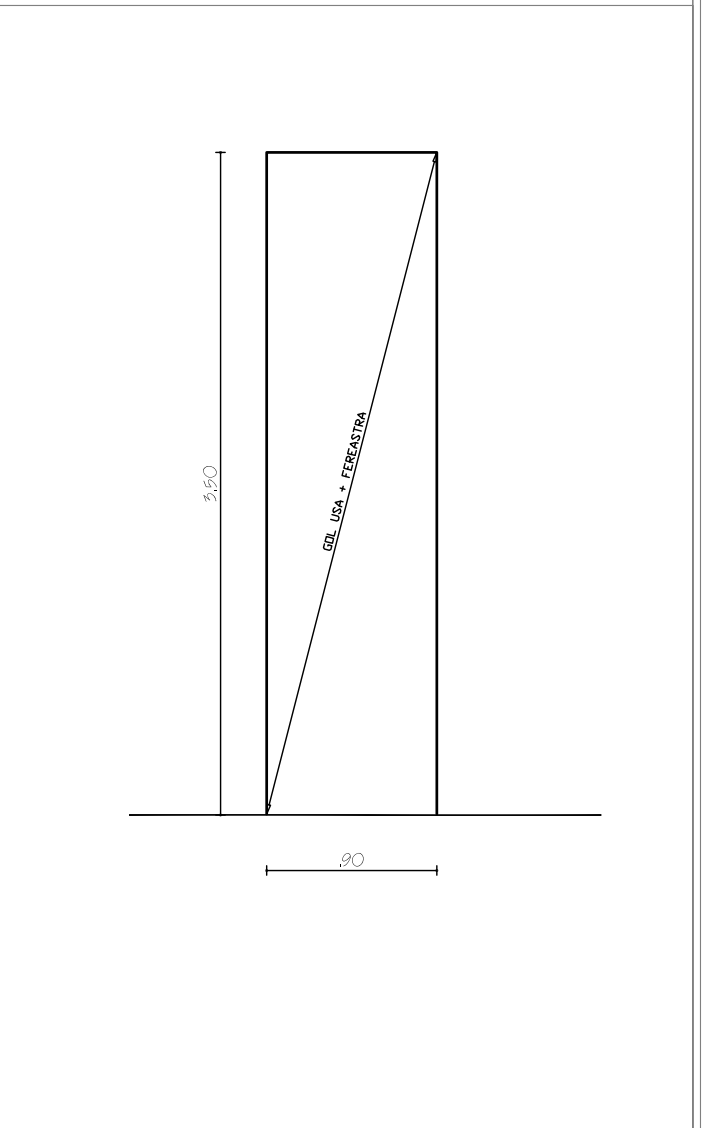
ELEVATIE TAMPLARIE SCARA 1:40

ELEVATIE GOL SCARA 1:40

PLAN SCARA 1:40

REVIZII	DATA	REV. NR. : 000
001		
002		
003		
004		

SECTIUNE SCARA 1:40
OBSERVATII :
 USA DE EXTERIOR

SEF PROIECT	arh. urb. Radu SIMION	FAZA :	D.D.E.	PROIECT NR : H_A_0216
PROIECTAT	arh. urb. Radu SIMION	DATA :	10.08.2016	REVIZIA : 000
DESENAT	arh. Dan-Nicu CRISTESCU			
DESENAT	arh. urb. Radu SIMION			
VERIFICAT	arh. Sandu STIURCA			

F_06
ASOCIATIA INFOCONS
**TABLOU TÂMLĂRIE
FERESTRE**
InfoCons
 protectia-consumatorilor.ro

 str.VIITORULUI 133
 S.2 BUCURESTI

DESCRIERE:
CARACTERISTICI TEHNICE :

 FEREAȘTRA CU TAMPLARIE DIN P.V.C., CU GEAM
 DUBLU TERMOIZOLANT, LOW-E, 2 CANATURI

CULDARE PIN

CARACTERISTICI FUNCȚIONALE :

DESCHIDERE BATANTA

AMPLASARE CORP LOCATIE

F_06

NUMAR BUCATI

2

ALCATUIRE PERETE

 ZIDARIE CARAMIDA 32cm
 TERMOȘISTEM - 10cm

REFERINȚE NORMATE

FARA AERISIRE

ELEVATIE TAMPLARIE

SCARA 1:40

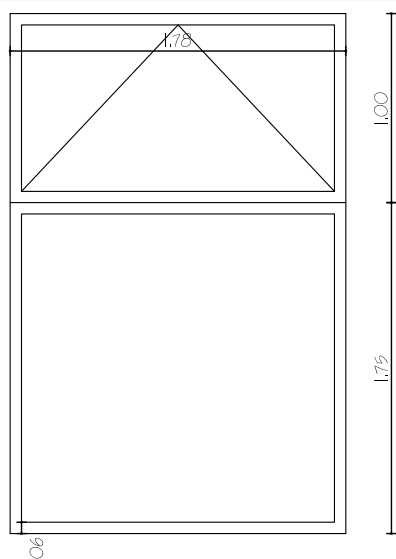
ELEVATIE GOL

SCARA 1:40

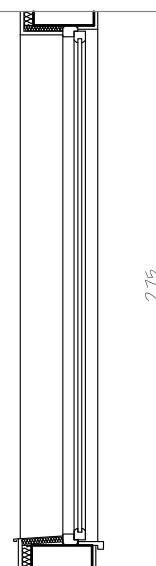
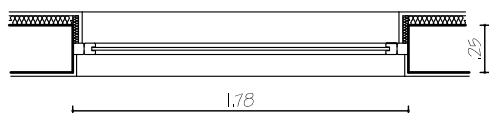
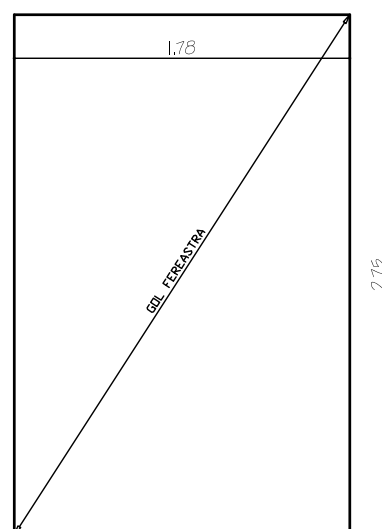
PLAN

SCARA 1:40

REVIZII	DATA
001	
002	
003	
004	

REV. NR. : 000
SECTIUNE

SCARA 1:40

 OBSERVATII :
 CURTE FRANCEZA

SEF PROIECT	arh. urb. Radu SIMION
PROIECTAT	arh. urb. Radu SIMION
DESENAT	arh. Dan-Nicu CRISTESCU
DESENAT	arh. urb. Radu SIMION
VERIFICAT	arh. Sandu STIURCA

FAZA : D.D.E.

PROIECT NR : H_A_0216

DATA : 10.08.2016

REVIZIA : 000

F_07**ASOCIATIA INFOCONS**
**TABLOU TÂMLĂRIE
FERESTRE**
InfoCons
 protectia-consumatorilor.ro

 str. VIITORULUI 133
 S.2 BUCURESTI
DESCRIERE:**CARACTERISTICI TEHNICE :**
 FEREAȘTRA CU TAMPLĂRIE DIN P.V.C., CU GEAM
 DUBLU TERMOIZOLANT, LOW-E, 2 CANATURI

CULOARE PIN

CARACTERISTICI FUNCȚIONALE :

DEȘCHIDERE BATANTĂ

AMPLASARE CORP LOCATIE

NUMAR BUCATI

ALCATUIRE PERETE

REFERINȚE NORMATE

F_07

1

ZIDĂRIE CĂRAMIDA 32cm
TERMOȘISTEM - 10cm

FĂRĂ AERISIRE

ELEVATIE TAMPLĂRIE

SCARA 1:40

ELEVATIE GOL

SCARA 1:40

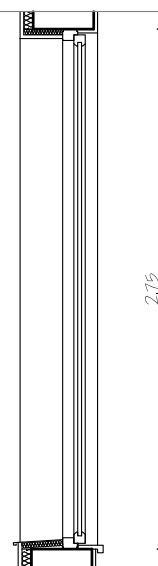
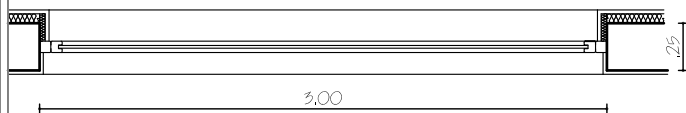
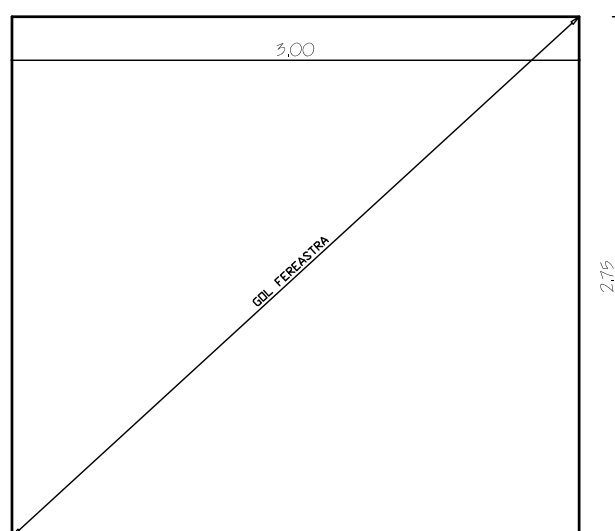
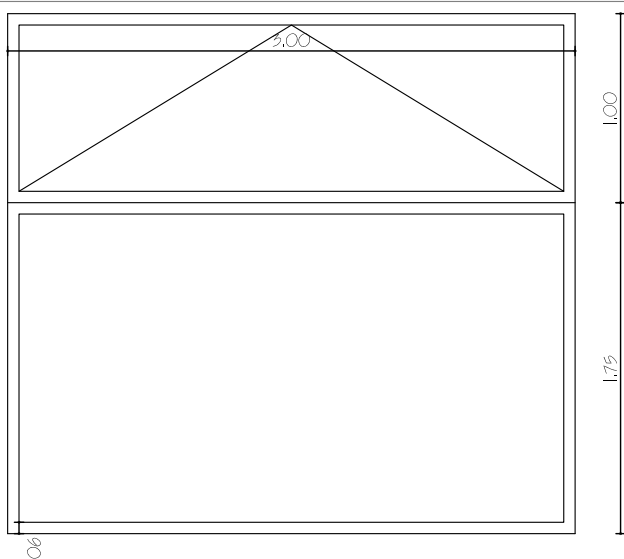
**PLAN**

SCARA 1:40

SECȚIUNE

SCARA 1:40

REVIZII DATA

REV. NR. : 000

OBSERVAȚII :
CURTE FRANCEZĂ

001

002

003

004

SEF PROIECT
PROIECTATarh. urb. Radu SIMION
arh. urb. Radu SIMIONFAZA :
D.D.E.

PROIECT NR : H_A_0216

DEȘENAT

arh. Dan-Nicu CRISTESCU

DATA :
10.08.2016

REVIZIA : 000

DEȘENAT

arh. urb. Radu SIMION

VERIFICAT

arh. Sandu ȘTIURCA

F_08**ASOCIATIA INFOCONS**
**TABLOU TÂMPLĂRIE
FERESTRE**
InfoCons
 protectia-consumatorilor.ro

 str.VIITORULUI 133
 S.2 BUCURESTI
DESCRIERE:**CARACTERISTICI TEHNICE :**
 FEREASTRA CU TAMPLARIE DIN P.V.C., CU GEAM
 DUBLU TERMOIZOLANT, LOW-E, 2 CANATURI

CULOARE PIN

CARACTERISTICI FUNCȚIONALE :

DESCHIDERE BATANTA

AMPLASARE CORP LOCATIE	NUMAR BUCATI	ALCATUIRE PERETE	REFERINȚE NORMATE
F_08	1	ZIDARIE CARAMIDA 32cm TERMOISISTEM - 10cm	FARA AERISIRE

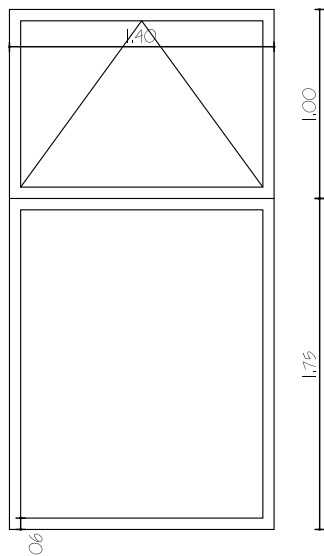
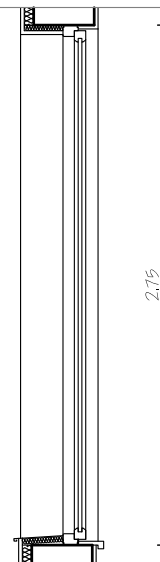
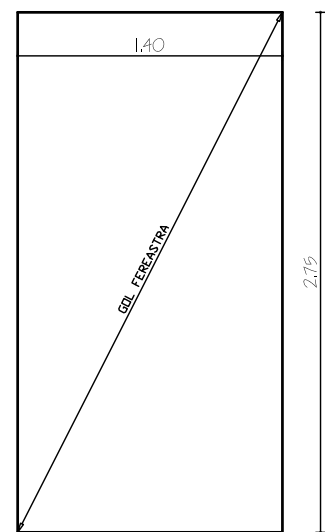
ELEVATIE TAMPLARIE SCARA 1:40**ELEVATIE GOL SCARA 1:40**

PLAN	SCARA 1:40	SECTIUNE	SCARA 1:40
------	------------	----------	------------

REVIZII	DATA	REV. NR. :	000
---------	------	------------	-----

001

002

003

004

 OBSERVATII :
 CURTE FRANCEZA

SEF PROIECT	arh. urb. Radu SIMION
PROIECTAT	arh. urb. Radu SIMION
DESENAT	arh. Dan-Nicu CRISTESCU
DESENAT	arh. urb. Radu SIMION
VERIFICAT	arh. Sandu STIURCA

FAZA : D.D.E.

PROIECT NR : H_A_0216

DATA : 10.08.2016

REVIZIA : 000

F_09

ASOCIATIA INFOCONS

**TABLOU TÂMPĂRIE
FERESTRE**
InfoCons
 protectia-consumatorilor.ro

 str.VIITORULUI 133
 S.2 BUCURESTI
DESCRIERE:**CARACTERISTICI TEHNICE :**
 FOAIE DE USA DIN STICLA, CU DOUA SAU TREI
 BALAMALE
 USA EXTERIOR
MATERIALE ȘI ACCESORII :
 STICLA SECURIZATA
 FARA TOC SAU TOC METALIC
 BALAMALE ALAMA
 MANER, SILD, ROZETA ALAMA

AMPLASARE CORP LOCATIE	NUMAR BUCATI	ALCATUIRE PERETE	FINISAJ
F_09	1-DESCHIDERE DREAPTA	ZIDARIE/B.A.	VOPSEA LAVABILA

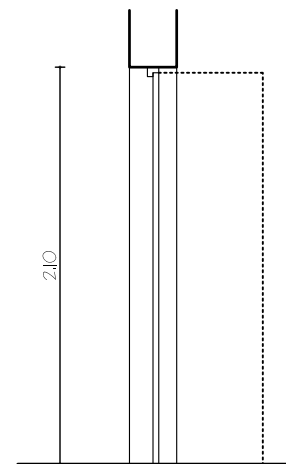
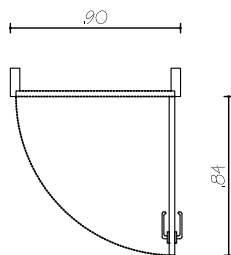
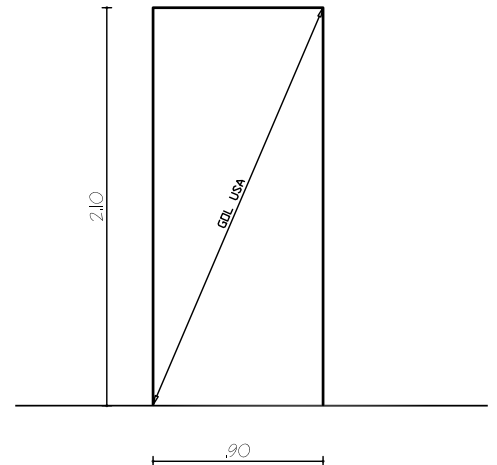
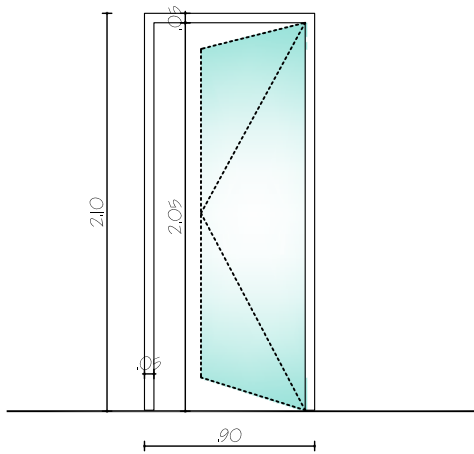
ELEVATIE TAMPLARIE SCARA 1:40
ELEVATIE GOL SCARA 1:40

PLAN SCARA 1:40
SECTIUNE SCARA 1:40

REVIZII	DATA	REV. NR. : 000
001		
002		
003		
004		

OBSERVATII :

USA DE INTERIOR

SEF PROIECT	arh. urb. Radu SIMION	FAZA :	D.D.E.	PROIECT NR : H_A_0216
PROIECTAT	arh. urb. Radu SIMION	DATA :	10.08.2016	REVIZIA : 000
DESENAT	arh. Dan-Nicu CRISTESCU			
DESENAT	arh. urb. Radu SIMION			
VERIFICAT	arh. Sandu STIURCA			

F_10

ASOCIATIA INFOCONS

**TABLOU TÂMPLĂRIE
FERESTRE**
InfoCons
 protectia-consumatorilor.ro

 str.VIITORULUI 133
 S.2 BUCURESTI
DESCRIERE:**CARACTERISTICI TEHNICE :**
 FOAIE DE USA DIN STICLA, CU DOUA SAU TREI
 BALAMALE
 USA EXTERIOR
MATERIALE ȘI ACCESORII :
 STICLA SECURIZATA
 FARA TOC SAU TOC METALIC
 BALAMALE ALAMA
 MANER, SILD, ROZETA ALAMA

AMPLASARE CORP LOCATIE	NUMAR BUCATI	ALCATUIRE PERETE	FINISAJ
F_10	1-DESCHIDERE DREAPTA	ZIDARIE/B.A.	VOPSEA LAVABILA

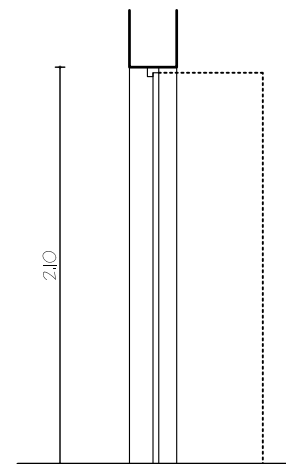
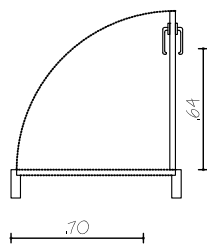
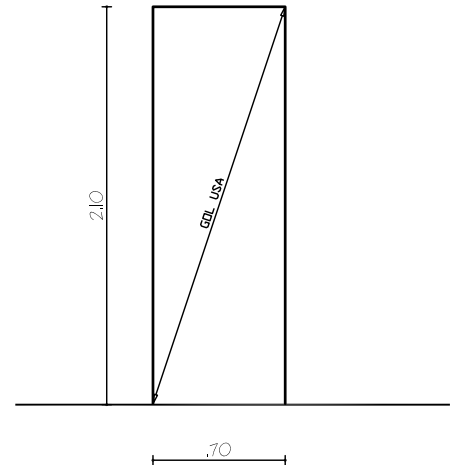
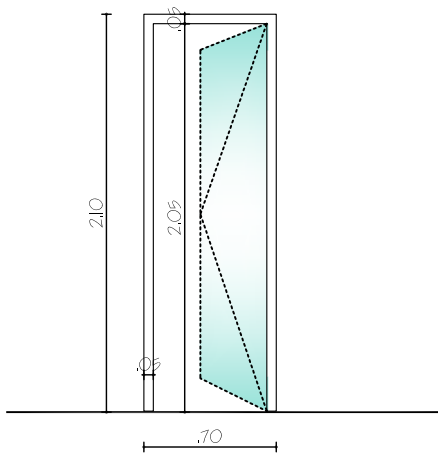
ELEVATIE TAMPLARIE SCARA 1:40
ELEVATIE GOL SCARA 1:40

PLAN SCARA 1:40
SECTIUNE SCARA 1:40

REVIZII	DATA	REV. NR. : 000
001		
002		
003		
004		

OBSERVATII :
 USA DE INTERIOR

SEF PROIECT	arh. urb. Radu SIMION	FAZA :	D.D.E.	PROIECT NR : H_A_0216
PROIECTAT	arh. urb. Radu SIMION	DATA :	10.08.2016	REVIZIA : 000
DESENAT	arh. Dan-Nicu CRISTESCU			
DESENAT	arh. urb. Radu SIMION			
VERIFICAT	arh. Sandu STIURCA			

F_11**ASOCIATIA INFOCONS****TABLOU TÂMPLĂRIE
FERESTRE****InfoCons**
protectia-consumatorilor.rostr. VIITORULUI 133
S.2 BUCURESTI**DESCRIERE:****CARACTERISTICI TEHNICE :**FEREAȘTRA CU TAMPLĂRIE DIN P.V.C., CU GEAM
DUBLU TERMOIZOLANT, LOW-E, 2 CANĂTURI

CULOARE PIN

CARACTERISTICI FUNCȚIONALE :

DEȘCHIDERE OSCILO-BĂTĂNTĂ

AMPLASARE CORP LOCĂȚIE

F_11

NUMĂR BUCĂȚI

1

ALCĂȚUIRE PERETEZIDĂRIE CĂRAMIDĂ 32cm
TERMOȘISTEM - 10cm**REFERINȚE NORMATE**

FĂRĂ AERISIRE

ELEVĂȚIE TAMPLĂRIE

SCĂRĂ 1:40

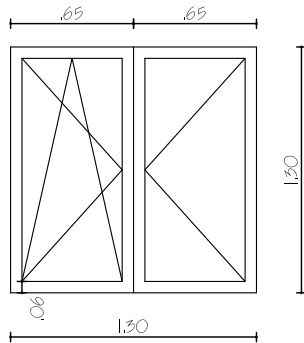
**ELEVĂȚIE GOL**

SCĂRĂ 1:40

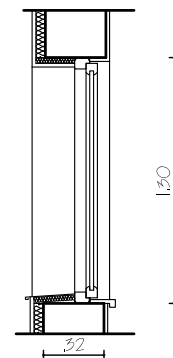
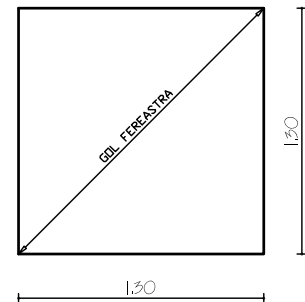
**PLAN**

SCĂRĂ 1:40

REVIZII	DATA
001	
002	
003	
004	

REV. NR. : 000**SECȚIUNE**

SCĂRĂ 1:40

OBSERVAȚII :
CURȚE FRANCEZĂ

SEF PROIECT	arh. urb. Radu SIMION	
PROIECTAT	arh. urb. Radu SIMION	
DEȘENAT	arh. Dan-Nicu CRISTESCU	
DEȘENAT	arh. urb. Radu SIMION	
VERIFICAT	arh. Sandu ȘTIURCĂ	

FAZĂ :
D.D.E.
DATA :
10.08.2016

PROIECT NR : H_A_0216

REVIZIA : 000

F_12

ASOCIATIA INFOCONS

**TABLOU TÂMPLĂRIE
FERESTRE**
InfoCons
 protectia-consumatorilor.ro

 str.VIITORULUI 133
 S.2 BUCURESTI
DESCRIERE:**CARACTERISTICI TEHNICE :**
 FEREASTRA CU TAMPLARIE DIN P.V.C., CU GEAM
 DUBLU TERMOIZOLANT, LOW-E, 1 CANAT

CULOARE PIN

CARACTERISTICI FUNCȚIONALE :

DESCHIDERE BATANTA

AMPLASARE CORP LOCATIE

NUMAR BUCATI

ALCATUIRE PERETE

REFERINȚE NORMATE

F_12

1

 ZIDARIE CARAMIDA 32cm
 TERMOISISTEM - 10cm

FARA AERISIRE

ELEVATIE TAMPLARIE

SCARA 1:40

ELEVATIE GOL

SCARA 1:40

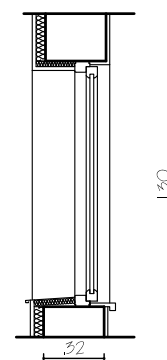
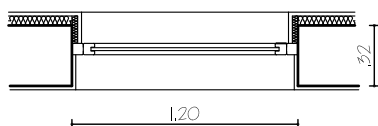
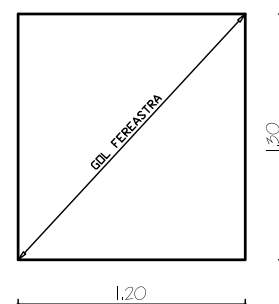
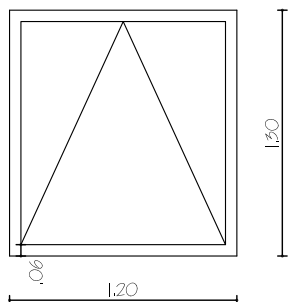

PLAN

SCARA 1:40

SECTIUNE

SCARA 1:40

REVIZII DATA

REV. NR. : 000

OBSERVATII :
CURTE FRANCEZA

001

002

003

004

SEF PROIECT

arh. urb. Radu SIMION

PROIECTAT

arh. urb. Radu SIMION

DESENAT

arh. Dan-Nicu CRISTESCU

DESENAT

arh. urb. Radu SIMION

VERIFICAT

arh. Sandu STIURCA

FAZA :

D.D.E.

PROIECT NR : H_A_0216

DATA :

10.08.2016

REVIZIA : 000

F_13

ASOCIATIA INFOCONS

**TABLOU TÂMLĂRIE
FERESTRE**
InfoCons
 protectia-consumatorilor.ro

 str. VIITORULUI 133
 S.2 BUCURESTI
DESCRIERE:**CARACTERISTICI TEHNICE :**
 FEREAȘTRA CU TAMPLĂRIE DIN P.V.C., CU GEAM
 DUBLU TERMOIZOLANT, LOW-E, 1 CANAT

CULOARE PIN

CARACTERISTICI FUNCȚIONALE :

DEȘCHIDERE OSCILO-BATĂNTĂ

AMPLASARE CORP LOCATIE	NUMAR BUCATI	ALCATUIRE PERETE	REFERINȚE NORMATE
F_13	3	ZIDARIE CARAMIDA 32cm TERMOȘISTEM - 10cm	FARA AERISIRE

ELEVATIE TAMPLARIE	SCARA 1:40	ELEVATIE GOL	SCARA 1:40
--------------------	------------	--------------	------------

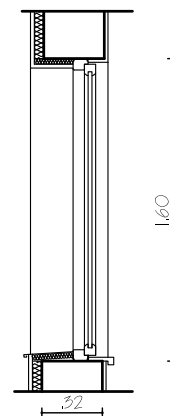
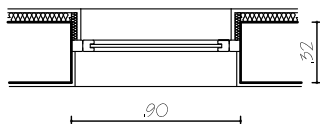
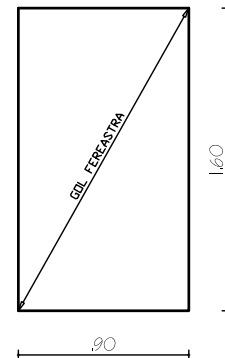
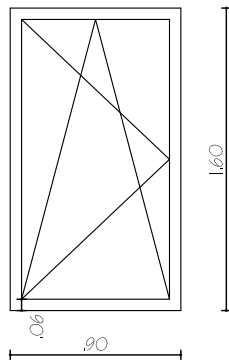

PLAN	SCARA 1:40	SECTIUNE	SCARA 1:40
------	------------	----------	------------

REVIZII	DATA	REV. NR. :	000
---------	------	------------	-----

001

002

003

004

 OBSERVAȚII :
 CURTE FRANCEZA

SEF PROIECT	arh. urb. Radu SIMION	
PROIECTAT	arh. urb. Radu SIMION	
DEȘENAT	arh. Dan-Nicu CRISTESCU	
DEȘENAT	arh. urb. Radu SIMION	
VERIFICAT	arh. Sandu ȘTIURCA	

FAZA : D.D.E. PROIECT NR : H_A_0216

DATA : 10.08.2016 REVIZIA : 000